

# JIS

JAPANESE  
INDUSTRIAL  
STANDARD

Translated and Published by  
Japanese Standards Association

---

JIS G 3302 : 2010

(JISF)

**Hot-dip zinc-coated steel sheet and  
strip**

---

ICS 77.140.50

Reference number : JIS G 3302 : 2010 (E)

PROTECTED BY COPYRIGHT

24 S

G 3302 : 2010

Date of Establishment: 1951-10-31

Date of Revision: 2010-06-21

Date of Public Notice in Official Gazette: 2010-06-21

Investigated by: Japanese Industrial Standards Committee  
Standards Board

Technical Committee on Iron and Steel

---

JIS G 3302 : 2010, First English edition published in 2011-04

Translated and published by: Japanese Standards Association  
4-1-24, Akasaka, Minato-ku, Tokyo, 107-8440 JAPAN

---

In the event of any doubts arising as to the contents,  
the original JIS is to be the final authority.

© JSA 2011

All rights reserved. Unless otherwise specified, no part of this publication may be reproduced or utilized in any form or by any means, electronic or mechanical, including photocopying and microfilm, without permission in writing from the publisher.

Printed in Japan

CK/HN

PROTECTED BY COPYRIGHT

## Contents

	Page
Introduction .....	1
1 Scope .....	1
2 Normative references .....	1
3 Grade, symbol and applicable nominal thickness .....	2
4 Chemical composition .....	3
5 Coating .....	4
5.1 Type of coating .....	4
5.2 Coating mass .....	4
5.3 Coating surface finishes .....	5
5.4 Coating adherence .....	6
6 Chemical treatment .....	7
7 Oiling .....	7
8 Mechanical properties .....	7
8.1 Applicable mechanical properties .....	7
8.2 Bendability .....	8
8.3 Tensile test characteristics .....	8
9 Dimensions and tolerances .....	10
9.1 Expression of dimensions .....	10
9.2 Standard dimensions .....	10
9.3 Dimensional tolerances .....	11
10 Shapes .....	14
10.1 Camber .....	14
10.2 Squareness .....	15
10.3 Flatness .....	16
11 Mass and tolerances thereof .....	17
11.1 Mass of sheet and corrugated sheet .....	17
11.2 Mass of coil .....	17
11.3 Calculation method of mass .....	17
11.4 Tolerances on theoretical mass of sheet and corrugated sheet .....	18
12 Appearance .....	18
13 Tests .....	19
13.1 Analysis test .....	19
13.2 Coating test .....	19
13.3 Mechanical test .....	20

14	Inspection and re-inspection .....	21
14.1	Inspection .....	21
14.2	Re-inspection .....	21
15	Marking .....	21
16	Items to be confirmed at the time of order .....	23
17	Report.....	23
Annex JA (normative)	Nominal thickness and coating mass symbol of sheet and coil for roofing and architectural siding .....	24
Annex JB (normative)	Nominal thickness, coating mass symbol and standard dimension for corrugated sheet .....	25
Annex JC (normative)	Off-line test method for coating mass of hot-dipped zinc-coated steel sheet and strip using fluorescent X-ray method .....	27
Annex JD (normative)	Online test method for coating mass of hot-dipped zinc-coated steel strip using fluorescent X-ray method .....	30
Annex JE (informative)	Comparison table between JIS and corresponding International Standards .....	35

## Foreword

This translation has been made based on the original Japanese Industrial Standard revised by the Minister of Economy, Trade and Industry, through deliberations at the Japanese Industrial Standards Committee as the result of proposal for revision of Japanese Industrial Standard submitted by The Japan Iron and Steel Federation (JISF) with the draft being attached, based on the provision of Article 12 Clause 1 of the Industrial Standardization Law applicable to the case of revision by the provision of Article 14.

Consequently **JIS G 3302:2007** has been replaced with this Standard.

However, **JIS G 3302:2007** may be applied in the JIS mark certification based on the relevant provisions of Article 19 Clause 1, etc. of the Industrial Standardization Law until 20th June, 2011.

This **JIS** document is protected by the Copyright Law.

Attention is drawn to the possibility that some parts of this Standard may conflict with a patent right, application for a patent after opening to the public, utility model right or application for registration of utility model after opening to the public which have technical properties. The relevant Minister and the Japanese Industrial Standards Committee are not responsible for identifying the patent right, application for a patent after opening to the public, utility model right or application for registration of utility model after opening to the public which have the said technical properties.

# Hot-dip zinc-coated steel sheet and strip

## Introduction

This Japanese Industrial Standard has been prepared based on the third edition of **ISO 3575** published in 2005 and the fourth edition of **ISO 4998** published in 2005 with some modifications of the technical contents.

The portions given sidelines or dotted underlines are the matters in which the contents of the corresponding International Standards have been modified. A list of modifications with the explanations is given in Annex JE. Furthermore, matters in Annex JA to Annex JD are not stated in the corresponding International Standards.

## 1 Scope

This Standard specifies the steel sheets and strips (hereafter referred to as "sheets and coils") and corrugated sheets manufactured by processing steel sheet into the shapes and dimensions specified in **JIS G 3316**, which are equally coated on both surfaces by hot-dip zinc coating process. The composition by mass fraction is 97 % or over zinc (provided that the aluminium content is usually 0.30 % or less).

NOTE : The International Standards corresponding to this Standard and the symbol of degree of correspondence are as follows:

**ISO 3575** : 2005 *Continuous hot-dip zinc-coated carbon steel sheet of commercial and drawing qualities*

**ISO 4998** : 2005 *Continuous hot-dip zinc-coated carbon steel sheet of structural quality* (Overall evaluation : MOD)

In addition, symbols which denote the degree of correspondence in the contents between the relevant International Standards and **JIS** are IDT (identical), MOD (modified), and NEQ (not equivalent) according to **ISO/IEC Guide 21-1**.

## 2 Normative references

The following standards contain provisions which, through reference in this text, constitute provisions of this Standard. The most recent editions of the standards (including amendments) indicated below shall be applied.

JIS G 0320 *Standard test method for heat analysis of steel products*

JIS G 0404 *Steel and steel products — General technical delivery requirements*

JIS G 0415 *Steel and steel products — Inspection documents*

JIS G 0594 *Methods of accelerated cyclic corrosion resistance tests for anodic coatings with exposure to salt spray, dry and wet conditions*

JIS G 3316 *Shapes and dimensions of corrugated steel sheets*

JIS H 0401 *Test methods for hot dip galvanized coatings*

NOTE : Corresponding International Standard: **ISO 1460** *Metallic coatings — Hot dip galvanized coatings on ferrous materials — Gravimetric determination of the mass per unit area (MOD)*

JIS H 8502 *Methods of corrosion resistance test for metallic coatings*

JIS K 0119 *General rules for X-ray fluorescence analysis*

JIS K 5600-7-9 *Testing methods for paints — Part 7: Determination of resistance to cyclic corrosion conditions — Section 9: Salt fog/dry/humidity*

JIS Z 2201 *Test pieces for tensile test for metallic materials*

JIS Z 2241 *Method of tensile test for metallic materials*

JIS Z 8401 *Guide to the rounding of numbers*

### 3 Grade, symbol and applicable nominal thickness <sup>1)</sup>

The grade, symbol and applicable nominal thickness shall be as follows.

Note <sup>1)</sup> The nominal thickness refers to the base metal thickness before coating [see **9.1 a)**].

- a) The sheets, corrugated sheets and coils shall be classified into 6 grades using hot-rolled sheets and strips (hereafter referred to as “hot-rolled base metal”) and into 11 grades using cold-reduced sheets and strips (hereafter referred to as “cold-reduced base metal”), and their grade symbols and applicable nominal thicknesses shall be as given in table 1 and table 2. Corrugated sheets shall be classified into 7 grades of commercial use, commercial use of hard class and commercial use of high strength class in table 2, and their respective symbols shall be as those affixed with symbol W, which stands for corrugated sheet, and the applicable symbol of shape of corrugation specified in **JIS G 3316** to the end of the symbol in table 2 (for those for roofing or architectural siding, after the symbol for roofing or architectural siding).

In this case, the applicable nominal thickness and the coating mass symbol shall be in accordance with Annex JB.

- b) For the sheets and coils used for roofing or architectural siding, the symbol R indicating roofing or the symbol A indicating architectural siding shall be suffixed to the grade symbol in table 2. In this case, the applicable nominal thickness and the coating mass symbol shall be in accordance with Annex JA.

**Table 1 Grade symbol and applicable nominal thickness  
[using hot-rolled base metal <sup>a)</sup>]**

Unit : mm

Symbol of grade	Applicable nominal thickness	Application
SGHC	1.6 or over up to and incl. 6.0	For commercial use
SGH340		For commercial use of high strength class
SGH400		
SGH440		
SGH490		
SGH540		
Note <sup>a)</sup> For the nominal thickness of 1.6 mm or over up to and including 3.2 mm, unless the hot-rolled base metal is particularly specified, the cold-reduced base metal which satisfies the specification of the hot-rolled base metal may be used.		

**Table 2 Grade symbol and applicable nominal thickness  
(using cold-reduced base metal)**

Unit : mm

Symbol of grade	Applicable nominal thickness <sup>a)</sup>	Application
SGCC	0.25 or over up to and incl. 3.2	For commercial use
SGCH	0.11 or over up to and incl. 1.0	For commercial use of hard class
SGCD1	0.40 or over up to and incl. 2.3	For drawing use Class 1
SGCD2		For drawing use Class 2
SGCD3	0.60 or over up to and incl. 2.3	For drawing use Class 3
SGCD4		For drawing use Class 4, non-aging property <sup>b)</sup>
SGC340	0.25 or over up to and incl. 3.2	For commercial use of high strength class
SGC400		
SGC440		
SGC490		
SGC570	0.25 or over up to and incl. 2.0	

Notes <sup>a)</sup> The nominal thickness other than those listed in this table may be applied upon the agreement between the purchaser and the supplier.

<sup>b)</sup> The non-aging property refers to the property free from the stretcher strain during working.

#### 4 Chemical composition

For the chemical composition of the sheet, corrugated sheet and coil, the test shall be performed in accordance with 13.1 and the resultant heat analysis values shall be as given in table 3. However, alloying elements other than those in table 3 may be added as required.

**Table 3 Chemical composition**

Unit : %

Symbol of grade	C	Mn	P	S
SGHC	0.15 max.	0.80 max.	0.05 max.	0.05 max.
SGH340	0.25 max.	1.70 max.	0.20 max.	0.05 max.
SGH400	0.25 max.	1.70 max.	0.20 max.	0.05 max.
SGH440	0.25 max.	2.00 max.	0.20 max.	0.05 max.
SGH490	0.30 max.	2.00 max.	0.20 max.	0.05 max.
SGH540	0.30 max.	2.50 max.	0.20 max.	0.05 max.
SGCC	0.15 max.	0.80 max.	0.05 max.	0.05 max.
SGCH	0.18 max.	1.20 max.	0.08 max.	0.05 max.
SGCD1	0.12 max.	0.60 max.	0.04 max.	0.04 max.
SGCD2	0.10 max.	0.45 max.	0.03 max.	0.03 max.
SGCD3	0.08 max.	0.45 max.	0.03 max.	0.03 max.
SGCD4	0.06 max.	0.45 max.	0.03 max.	0.03 max.
SGC340	0.25 max.	1.70 max.	0.20 max.	0.05 max.
SGC400	0.25 max.	1.70 max.	0.20 max.	0.05 max.
SGC440	0.25 max.	2.00 max.	0.20 max.	0.05 max.
SGC490	0.30 max.	2.00 max.	0.20 max.	0.05 max.
SGC570	0.30 max.	2.50 max.	0.20 max.	0.05 max.



## 5 Coating

### 5.1 Type of coating

The coating shall be classified into 2 types: non-alloyed coating and alloyed coating <sup>2)</sup>.

Note <sup>2)</sup> The alloyed coating refers to the coating obtained in such a way that an alloyed layer of zinc and iron is produced in the entire coating layer by heating after coating.

### 5.2 Coating mass

#### 5.2.1 Coating mass symbol

For coating, both surfaces shall be equally coated in thickness, and the coating mass symbol shall be as given in table 4.

#### 5.2.2 Coating mass

For the coating mass, the test shall be performed in accordance with **13.2.2** and the minimum coating mass shall be as follows. The maximum coating mass (total mass on both surfaces) may be agreed between the purchaser and the supplier.

- a) The coating mass on the sheets, corrugated sheets and coils shall be expressed by the total mass on both surfaces, and the minimum average coating mass at triple spots and the minimum coating mass at a single spot shall be as given in table 4. Here, the minimum average coating mass at triple spots shall apply to the average of the measured values of the coating masses of three test pieces cut from the sample, and the minimum coating mass at a single spot shall apply to the smallest of the measured values of the coating masses of the three test pieces of which the average value is obtained. However, when measuring the coating mass on the sheet according to Annex JD, apply to the average coating mass and the minimum average coating mass obtained according to **JD.6.5.**

**Table 4 Minimum coating mass (total mass on both surfaces)**

Unit : g/m <sup>2</sup>			
Type of coating	Coating mass symbol	Minimum average coating mass at triple spots	Minimum coating mass at single spot
Non-alloyed coating	Z06 <sup>a)</sup>	60	51
	Z08	80	68
	Z10	100	85
	Z12	120	102
	Z14	140	119
	Z18	180	153
	Z20	200	170
	Z22	220	187
	Z25	250	213
	Z27	275	234
	Z35	350	298
	Z37	370	315
	Z45	450	383
	Z60	600	510
Alloyed coating	F04 <sup>a)</sup>	40	34
	F06	60	51
	F08	80	68
	F10	100	85
	F12	120	102
	F18 <sup>a)</sup>	180	153
The coating masses corresponding to Z35, Z37, Z45, Z60, F10, F12 and F18 shall not apply to SGCD1, SGCD2, SGCD3 and SGCD4. Note <sup>a)</sup> Applicable only when agreed between the purchaser and the supplier.			

b) The minimum coating mass at a single spot on either surface on the sheet, corrugated sheet and coil should be 40 % or over of the minimum coating mass at a single spot (total mass on both surfaces).

### 5.3 Coating surface finishes

#### 5.3.1 Type and symbol of surface finish for non-alloyed coating

The type and the symbol of the coating surface finish shall be as given in table 5.

**Table 5 Type and symbol of surface finish for non-alloyed coating**

Type of coating surface finish	Symbol	Remarks
Regular spangle	R	A coating having spangles as a result of the unrestricted growth of zinc crystals during normal solidification.
Minimized spangle	Z	A coating having the spangles obtained by restricting normal spangle formation to a minimum.

### 5.3.2 Skin-pass

Skin-passing to obtain surface smoothness shall be in accordance with the designation by the purchaser. In this case, the symbol shall be S.

### 5.4 Coating adherence

For the coating adherence of the sheets, corrugated sheets and coils to which the non-alloyed coating is applied, when the test is performed in accordance with **13.2.3** under the bend test condition given in table 6 or table 7, there shall be no flaking of the coating on the outside of the bent portion (within an area 7 mm or over from each side of the test piece). However, in the case of the corrugated sheets, apply to the sheets before corrugation.

In addition, unless designated by the purchaser, the coating adherence may be evaluated by the manufacturer in accordance with other evaluation test methods or evaluation criteria in place of the bend test for coating adherence. In this case, the evaluation shall be at least equivalent to the coating adherence by the bend test of table 6 or table 7.

**Table 6 Bend test condition (1)**

Symbol of grade	Bend angle	Internal spacing of bend (number of sheets of nominal thickness)					
		Nominal thickness 1.6 mm or over to and excl. 3.0 mm			Nominal thickness 3.0 mm or over		
		Coating mass symbol			Coating mass symbol		
		Z06 to Z27	Z35, Z37	Z45, Z60	Z06 to Z27	Z35, Z37	Z45, Z60
SGHC	180°	1	2	2	2	2	2
SGH340		1	1	2	2	2	3
SGH400		2	2	2	3	3	3
SGH440		3	3	3	3	3	3
SGH490							
SGH540							

**Table 7 Bend test condition (2)**

Symbol of grade	Bend angle	Internal spacing of bend (number of sheets of nominal thickness)								
		Nominal thickness Under 1.6 mm			Nominal thickness 1.6 mm or over to and excl. 3.0 mm			Nominal thickness 3.0 mm or over		
		Coating mass symbol			Coating mass symbol			Coating mass symbol		
		Z06 to Z27	Z35, Z37	Z45, Z60	Z06 to Z27	Z35, Z37	Z45, Z60	Z06 to Z27	Z35, Z37	Z45, Z60
SGCC	180°	1	1	2	1	2	2	2	2	2
SGCD1		1	—	—	1	—	—	—	—	—
SGCD2		0 (Flat on itself)	—	—	0 (Flat on itself)	—	—	—	—	—
SGCD3										
SGCD4										
SGC340		1	1	2	1	1	2	2	2	3
SGC400		2	2	2	2	2	2	3	3	3
SGC440		3	3	3	3	3	3	3	3	3
SGC490										

## 6 Chemical treatment

The types and symbols of the chemical treatment for the sheets, corrugated sheets and coils shall be as given in table 8. Unless otherwise specified, the non-alloyed coating shall be subjected to the chromate treatment or chromate-free treatment, and the alloyed coating shall be untreated.

The type of chemical treatment other than those in table 8 may be agreed upon between the purchaser and the supplier.

**Table 8 Type and symbol of chemical treatment**

Type of chemical treatment	Symbol
Chromate treatment	C
Phosphate treatment <sup>a)</sup>	P
Chromate-free treatment <sup>b)</sup>	NC
Chromate-free phosphate treatment <sup>c)</sup>	NP
Untreated	M
Notes <sup>a)</sup> <u>For phosphate treatment, chromate treatment shall generally be applied on the phosphate-treated surface in order to improve the corrosion resistance.</u> <sup>b)</sup> <u>Chromate-free treatment refers to the chemical treatment which does not contain the hexavalent chromium.</u> <sup>c)</sup> <u>Chromate-free phosphate treatment refers to the chemical treatment which does not contain hexavalent chromium applied on the phosphate-treated surface.</u>	

## 7 Oiling

The type and the symbol of oiling for the sheets, corrugated sheets and coils shall be as given in table 9. Unless otherwise specified, the non-alloyed coating shall be unoiled and the alloyed coating shall be oiled.

**Table 9 Type and symbol of oiling**

Type of oiling	Symbol
Oiled	○
Unoiled	×

## 8 Mechanical properties

### 8.1 Applicable mechanical properties

Applicable mechanical properties for the sheets, corrugated sheets and coils shall be as given in table 10. However, in the case of the corrugated sheets, apply to the sheets before corrugation.

**Table 10 Applicable mechanical property**

Symbol of grade	Bendability <sup>a)</sup>	Tensile test characteristics <sup>b)</sup>
SGHC	○	— <sup>c)</sup>
SGH340	○	○
SGH400	○	○
SGH440	○	○
SGH490	○	○
SGH540	○	○
SGCC	○ <sup>d)</sup>	— <sup>c)</sup>
SGCH	— <sup>e)</sup>	— <sup>c)</sup>
SGCD1	○	○
SGCD2	○	○
SGCD3	○	○
SGCD4	○	○
SGC340	○	○
SGC400	○	○
SGC440	○	○
SGC490	○	○
SGC570	— <sup>e)</sup>	○
Notes <sup>a)</sup> Apply to the non-alloyed coating and not apply to the alloyed coating. <sup>b)</sup> For the nominal thickness under 0.25 mm, the tensile test shall not apply. <sup>c)</sup> The tensile test characteristics shall not apply. <sup>d)</sup> <del>When used for corrugated sheets, the bendability shall not apply.</del> <sup>e)</sup> The bendability shall not apply.		

## 8.2 Bendability

For the bendability of the sheets, corrugated sheets and coils to which the non-alloyed coating is applied, when the test is performed in accordance with **13.3.2** under the bend test conditions given in table 6 and table 7, there shall be no cracking (visible to the naked eye) and no fracture of the base metal on the outside of the bent portion (within an area 7 mm or over from each side of the test piece).

NOTE : For the performance of the bend test, see **13.3.2**.

## 8.3 Tensile test characteristics

For the tensile test characteristics of the sheets, ~~corrugated sheets~~ and coils, when the test is performed in accordance with **13.3.3**, the result shall be as given in table 11 or table 12. However, the values of table 11 or table 12 shall apply to those of outgoing inspection <sup>3)</sup>.

Note <sup>3)</sup> Age-hardening of sheets, ~~corrugated sheets~~ and coils can cause increase in yield point or proof stress and decrease in elongation.

**Table 11 Tensile test characteristics (1)**

Symbol of grade	Yield point or proof stress  N/mm <sup>2</sup>	Tensile strength  N/mm <sup>2</sup>	Elongation %					Test piece and direction of tensile test
			Nominal thickness mm					
			1.6 or over to and excl. 2.0	2.0 or over to and excl. 2.5	2.5 or over to and excl. 3.2	3.2 or over to and excl. 4.0	4.0 or over up to and incl. 6.0	
SGHC	(205 min.)	(270 min.)	—	—	—	—	—	No. 5 in rolling direction
SGH340	245 min.	340 min.	20 min.	20 min.	20 min.	20 min.	20 min.	No. 5 in rolling direction or perpendicular to the rolling direction
SGH400	295 min.	400 min.	18 min.	18 min.	18 min.	18 min.	18 min.	
SGH440	335 min.	440 min.						
SGH490	365 min.	490 min.	16 min.	16 min.	16 min.	16 min.	16 min.	
SGH540	400 min.	540 min.						
Values in parentheses are shown for reference. However, they may apply as specified value according to agreement between the purchaser and the supplier. NOTE : 1 N/mm <sup>2</sup> = 1 MPa								

**Table 12 Tensile test characteristics (2)**

Symbol of grade	Yield point or proof stress  N/mm <sup>2</sup>	Tensile strength  N/mm <sup>2</sup>	Elongation %						Test piece and direction of tensile test
			Nominal thickness mm						
			0.25 or over to and excl. 0.40	0.40 or over to and excl. 0.60	0.60 or over to and excl. 1.0	1.0 or over to and excl. 1.6	1.6 or over to and excl. 2.5	2.5 or over	
SGCC	(205 min.)	(270 min.)	—	—	—	—	—	—	No. 5 in rolling direction
SGCH	—	—	—	—	—	—	—	—	
SGCD1	—	270 min.	—	34 min.	36 min.	37 min.	38 min.	—	
SGCD2	—	270 min.	—	36 min.	38 min.	39 min.	40 min.	—	
SGCD3	—	270 min.	—	38 min.	40 min.	41 min.	42 min.	—	
SGCD4 <sup>a)</sup>	—	270 min.	—	40 min.	42 min.	43 min.	44 min.	—	
SGC340	245 min.	340 min.	20 min.	20 min.	20 min.	20 min.	20 min.	20 min.	No. 5 in rolling direction or perpendicular to the rolling direction
SGC400	295 min.	400 min.	18 min.	18 min.	18 min.	18 min.	18 min.	18 min.	
SGC440	335 min.	440 min.	18 min.	18 min.	18 min.	18 min.	18 min.	18 min.	
SGC490	365 min.	490 min.	16 min.	16 min.	16 min.	16 min.	16 min.	16 min.	
SGC570	560 min.	570 min.	—	—	—	—	—	—	
Values in parentheses are shown for reference. However, they may apply as specified value according to the agreement between the purchaser and the supplier. NOTE 1 SGCH is a material not subjected to annealing, usually having a Rockwell hardness of 85 HRB or more or a Vickers hardness of 170 HV or more. NOTE 2 1 N/mm <sup>2</sup> = 1 MPa Notes <sup>a)</sup> For the sheet and coil of SGCD4, the stretcher strain shall not be generated when working is performed during 6 months after manufacturing.									

## 9 Dimensions and tolerances

### 9.1 Expression of dimensions

The dimensions of sheets, corrugated sheets and coils shall be expressed as follows.

- For the thickness of sheets, corrugated sheets and coils, the thickness of the base metal before coating shall be regarded as the nominal thickness and the thickness of the base metal after coating shall be regarded as the product thickness.
- The dimensions of sheets and corrugated sheets shall be expressed by nominal thickness, width and length in millimetres.
- The dimensions of coil shall be expressed by nominal thickness and width in millimetres. When the mass of coil is the theoretical mass, the length shall be expressed in metres.

### 9.2 Standard dimensions

The standard dimensions of sheets and coils shall be as follows. The standard nominal thickness of corrugated sheets, standard width and length before corrugation shall be in accordance with Annex JB. Further, the standard length and width of corrugated sheets after corrugation shall be in accordance with **JIS G 3316**.

- Standard nominal thickness** The standard nominal thickness of sheets and coils shall be as given in table 13.

**Table 13 Standard nominal thickness**

Unit : mm

Standard nominal thickness											
(0.27)	(0.30)	(0.35)	0.40	0.50	0.60	0.70	0.80	0.90	1.0	1.2	1.4
1.6	1.8	2.0	2.3	2.8	3.2	3.6	4.0	4.5	5.0	5.6	6.0

Values in parentheses shall apply to the coating mass or more coatings corresponding to the non-alloyed Z18. Upon the agreement between the purchaser and the supplier, the thicknesses of 0.65 mm and 0.75 mm may serve as the standard nominal thicknesses.

- Standard width and standard length of sheet** The standard width of sheets and coils, and the standard length of sheets shall be as given in table 14.

**Table 14 Standard width and standard length of sheet**

Unit : mm

Standard width	Standard length of sheet								
762	1 829	2 134	2 438	2 743	3 048	3 353	3 658		
914	1 829	2 134	2 438	2 743	3 048	3 353	3 658		
1 000	2 000								
1 219	2 438	3 048	3 658						
1 524	3 048								
1 829	3 658								

As for the coil, 610 mm shall also be regarded as the standard width in addition to those given in this table.

### 9.3 Dimensional tolerances

#### 9.3.1 Tolerances on product thickness

Tolerances on the product thickness of sheets, corrugated sheets and coils shall be as follows.

- a) Tolerances on the product thickness shall apply to the value of the nominal thickness rounded to three decimal places plus the equivalent thickness of the coating given in table 15 rounded to two decimal places in accordance with rule A of **JIS Z 8401**.
- b) Tolerances on the product thickness shall be as given in table 16, table 17 or table 18.
- c) The product thickness shall be measured at any point 25 mm or over from the side edge (the end in the width direction) .
- d) They shall not apply to the irregular portions such as the welds in a coil.

**Table 15 Equivalent coating thickness**

Non-alloyed coating

Unit : mm

Coating mass symbol	Z06	Z08	Z10	Z12	Z14	Z18	Z20	Z22	Z25	Z27	Z35	Z37	Z45	Z60
Equivalent coating thickness	0.013	0.017	0.021	0.026	0.029	0.034	0.040	0.043	0.049	0.054	0.064	0.067	0.080	0.102

Alloyed coating

Coating mass symbol	F04	F06	F08	F10	F12	F18
Equivalent coating thickness	0.008	0.013	0.017	0.021	0.026	0.034

**Table 16 Tolerances on product thickness (applicable to SGHC)**

Unit : mm

Nominal width	Width			
	Under 1 200	1 200 or over to and excl. 1 500	1 500 or over to and excl. 1 800	1 800 or over up to and incl. 2 300
1.60 or over to and excl. 2.00	± 0.17	± 0.18	± 0.19	± 0.22 <sup>a)</sup>
2.00 or over to and excl. 2.50	± 0.18	± 0.20	± 0.22	± 0.26 <sup>a)</sup>
2.50 or over to and excl. 3.15	± 0.20	± 0.22	± 0.25	± 0.27
3.15 or over to and excl. 4.00	± 0.22	± 0.24	± 0.27	± 0.28
4.00 or over to and excl. 5.00	± 0.25	± 0.27	—	—
5.00 or over to and excl. 6.00	± 0.27	± 0.29	—	—
6.00	± 0.30	± 0.31	—	—

Note <sup>a)</sup> Applicable to those of width under 2 000 mm.



**Table 17 Tolerances on product thickness (applicable to SGH340, SGH400, SGH440, SGH490 and SGH540)**

Unit : mm

Nominal thickness	Width	
	Under 1 600	1 600 or over to and excl. 2 000
1.60 or over to and excl. 2.00	± 0.20	± 0.24
2.00 or over to and excl. 2.50	± 0.21	± 0.26
2.50 or over to and excl. 3.15	± 0.23	± 0.30
3.15 or over to and excl. 4.00	± 0.25	± 0.35
4.00 or over to and excl. 5.00	± 0.46	—
5.00 or over up to and incl. 6.00	± 0.51	—

**Table 18 Tolerances on product thickness (applicable to SGCC, SGCH, SGCD1 to SGCD4 and SGC340 to SGC570)**

Unit : mm

Nominal thickness	Width				
	Under 630	630 or over to and excl. 1 000	1 000 or over to and excl. 1 250	1 250 or over to and excl. 1 600	1 600 or over
Under 0.25 <sup>a)</sup>	(± 0.04)	(± 0.04)	(± 0.04)	—	—
0.25 or over to and excl. 0.40	± 0.05	± 0.05	± 0.05	± 0.06	—
0.40 or over to and excl. 0.60	± 0.06	± 0.06	± 0.06	± 0.07	± 0.08
0.60 or over to and excl. 0.80	± 0.07	± 0.07	± 0.07	± 0.07	± 0.08
0.80 or over to and excl. 1.00	± 0.07	± 0.07	± 0.08	± 0.09	± 0.10
1.00 or over to and excl. 1.25	± 0.08	± 0.08	± 0.09	± 0.10	± 0.12
1.25 or over to and excl. 1.60	± 0.09	± 0.10	± 0.11	± 0.12	± 0.14
1.60 or over to and excl. 2.00	± 0.11	± 0.12	± 0.13	± 0.14	± 0.16
2.00 or over to and excl. 2.50	± 0.13	± 0.14	± 0.15	± 0.16	± 0.18
2.50 or over to and excl. 3.15	± 0.15	± 0.16	± 0.17	± 0.18	± 0.21
3.15 or over up to and incl. 3.20	± 0.17	± 0.18	± 0.20	± 0.21	—
Over 3.20 <sup>a)</sup>	(± 0.17)	(± 0.18)	(± 0.20)	(± 0.21)	—

The tolerances in parentheses are shown for reference. In accordance with the agreement between the purchaser and the supplier, however, these values may be applied as specified values.

Note <sup>a)</sup> Nominal thickness applied upon the agreement between the purchaser and the supplier.

### 9.3.2 Tolerances on width

The tolerances on the width of sheets and coils shall be as given tables 19, 20 and 21. Table 19 applies to those cut by the normal method, table 20 to those cut again or precisely cut and table 21 to those slit. The width shall be measured at a normal position in a coil and at any position in the sheet. The tolerances on width in table

20 may shift to the minus side within the same range as the overall range of tolerances specified in table 20. The upper limits of tolerances, however, shall not be less than zero.

However, tolerances on the width of corrugated sheets after corrugation shall be in accordance with **JIS G 3316**.

**Table 19 Tolerances on width (1)**

Unit : mm

Width	Applicable grade symbol		
	SGHC, SGH340, SGH400, SGH440, SGH490, SGH540		SGCC, SGCH, SGCD1 to SGCD4, SGC340 to SGC570
	Tolerance A <sup>a)</sup>	Tolerance B <sup>a)</sup>	
1 500 or under	+ 25 0	+ 10 0	+ 7 0
Over 1 500			+ 10 0

Note <sup>a)</sup> Generally, tolerance A is applied to the mill edge and tolerance B is applied to the cut edge.

**Table 20 Tolerances on width (2)**

Unit : mm

Width	
Under 1 250	1 250 or over
+ 3 0	+4 0

**Table 21 Tolerances on width (3)**

Unit : mm

Nominal thickness	Width			
	Under 160	160 or over to and excl. 250	250 or over to and excl. 400	400 or over to and excl. 630
Under 0.25 <sup>a)</sup>	(±0.15)	(±0.20)	(±0.25)	(±0.30)
0.25 or over to and excl. 0.60	±0.15	±0.20	±0.25	±0.30
0.60 or over to and excl. 1.00	±0.20	±0.25	±0.25	±0.30
1.00 or over to and excl. 1.60	±0.20	±0.30	±0.30	±0.40
1.60 or over to and excl. 2.50	±0.25	±0.35	±0.40	±0.50
2.50 or over to and excl. 3.20	±0.30	±0.40	±0.45	±0.50
3.20 or over	±0.50	±0.50	±0.50	±0.50

The tolerances in parentheses are shown for reference. In accordance with the agreement between the purchaser and the supplier, however, these values may be applied as specified values.

Note <sup>a)</sup> Nominal thickness applied upon the agreement between the purchaser and the supplier.

### 9.3.3 Tolerances on length

The tolerances on the length of sheets and corrugated sheets shall be as given in table 22. The length shall be measured at any position in the sheet and corrugated sheet.

**Table 22 Tolerances on length**

Unit : mm	
Tolerances on length	
+ 15	
0	

**10 Shapes**

**10.1 Camber**

The application of camber for the sheets, corrugated sheets and coils shall be as shown in figure 1. However, in the case of corrugated sheets, they shall be applied to the sheets before corrugation. The maximum camber of the sheets, corrugated sheets and coils shall be as given in table 23 or table 24. However, the camber shall not apply to the irregular portions in a coil. The measurement of camber may be omitted<sup>4)</sup>, however, when particularly specified by the purchaser, the measurement shall be performed.

Note <sup>4)</sup> The measurement of camber may be omitted by the judgement of the manufacturer on the precondition that camber shall satisfy the specified value.

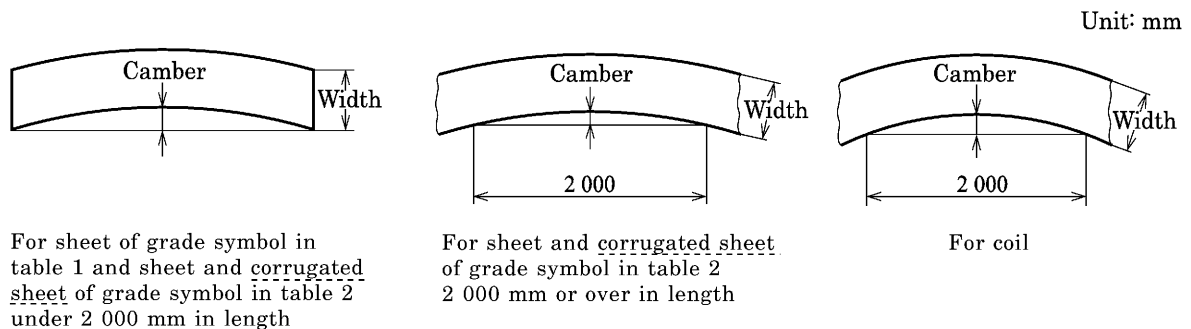

**Figure 1 Application of camber**

**Table 23 Maximum value of camber (applicable for SGHC, SGH340, SGH400, SGH440, SGH490 and SGH540)**

Width	Sheet			Coil
	Length			
	Under 2 500	2 500 or over to and excl. 4 000	4 000 or over	
Under 630	5	8	12	5 in any 2 000 length
630 or over to and excl. 1 000	4	6	10	
1 000 or over	3	5	8	

**Table 24 Maximum value of camber (applicable for SGCC, SGCH, SGCD1 to SGCD4 and SGC340 to SGC570)**

Width	Sheet and corrugated sheet		Coil
	Length		
	Under 2 000	2 000 or over	
Under 630	4	4 in any 2 000 length	
630 or over	2	2 in any 2 000 length	

### 10.2 Squareness

The squareness of the sheets and corrugated sheets shall be in accordance with either of the following. For the corrugated sheets, however, it applies to the sheet before corrugation. In addition, if any doubt arises, a) shall apply.

- a) **Method using perpendicular line** The squareness of sheets and corrugated sheets is expressed by the ratio  $A/B$ , where  $A$  indicates the distance between a perpendicular line which is dropped at a corner point of one side and another corner point of opposite side, and  $B$  indicates the length of the perpendicular line, and the value shall not exceed 1.0 %.

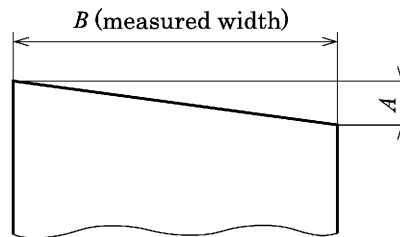

**Figure 2 Squareness of sheet or corrugated sheet (method using perpendicular line)**

- b) **Method using diagonal lines** Half of the absolute value of the difference ( $|X_1 - X_2|/2$ ) between each length of two diagonal lines ( $X_1$  and  $X_2$  in figure 3) of the sheet or corrugated sheet is obtained, and the value shall not exceed 0.7 % of the measured width of the sheet and corrugated sheet.

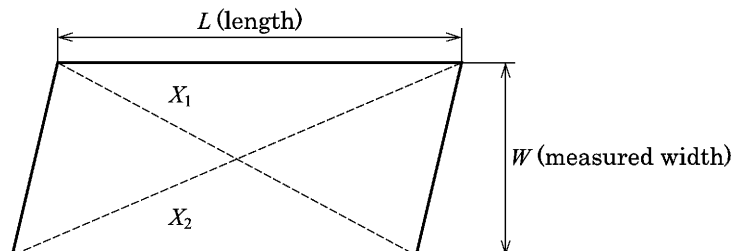

**Figure 3 Squareness of sheet or corrugated sheet (method using diagonal lines)**

### 10.3 Flatness

The flatness of the sheets and coils shall be as following.

- a) **Flatness of sheets** The flatness of the sheets shall be as given in table 25 or table 26. The flatness shall be measured with a sheet lying on a level block and its value shall be obtained by subtracting the product thickness from the maximum strain and shall apply to the upper surface of the sheet.

**Table 25 Flatness for the sheet (applicable to SGHC, SGH340, SGH400, SGH440, SGH490 and SGH540)**

Unit : mm

Nominal thickness	Width			
	Under 1 250	1 250 or over to and excl. 1 600	1 600 or over to and excl. 2 000	2 000 or over up to and incl. 2 300
1.60 or over to and excl. 3.15	16 max.	18 max.	20 max.	—
3.15 or over to and excl. 4.00	16 max.			—
4.00 or over to and excl. 6.00	14 max.			24 max.
6.00	13 max.			21 max.

**Table 26 Flatness for the sheet (applicable to SGCC, SGCH, SGCD1 to SGCD4 and SGC340 to SGC570)**

Unit : mm

Width	Type of strain <sup>a)</sup>		
	Bow, wave	Edge wave	Centre buckle
Under 1 000	12 max.	8 max.	6 max.
1 000 or over to and excl. 1 250	15 max.	9 max.	8 max.
1 250 or over to and excl. 1 600	15 max.	11 max.	8 max.
1 600 or over	20 max.	13 max.	9 max.

Note <sup>a)</sup> According to its shape and location of occurrence, the strain is categorized as follows.  
 Bow: curving of the whole steel sheet, either in the rolling direction or in the direction transverse to the rolling direction  
 Wave: rippling in rolling direction of the steel sheet  
 Edge wave: wave appearing on the edge of steel sheet (end part in the width direction)  
 Centre buckle: wave appearing on the centre part of the steel sheet

- b) **Flatness of coils** The flatness of coils shall be as given in table 25 or 26, provided that it is not applicable to the bow. Also, it shall not apply to the irregular parts of the coil. The flatness of coils shall be inspected on the inspection station installed on the production line. When the measurement value is necessary, the measurement including the measurement method shall be reported upon the agreement between the purchaser and the manufacturer.

The measurement of flatness of coils may be omitted <sup>5)</sup>.

Note <sup>5)</sup> The omission of the measurement of flatness based on the judgement of the manufacturer is permissible on the precondition that the flatness shall satisfy the specified value.

## 11 Mass and tolerances thereof

### 11.1 Mass of sheet and corrugated sheet

The mass of sheets and corrugated sheets shall usually be given in the theoretical mass in kilogrammes.

### 11.2 Mass of coil

The mass of coils shall be given in either the actual or the theoretical mass in kilogrammes.

### 11.3 Calculation method of mass

The calculation method of the mass of sheets, corrugated sheets and coils shall be as given in table 27.

**Table 27 Calculation method of mass**

Calculation order		Calculation method	Number of figures in resultant values <sup>a)</sup>
Basic mass of base metal kg/(mm·m <sup>2</sup> )		7.85 <sup>b)</sup>	—
Unit mass of base metal kg/m <sup>2</sup>		Basic mass of base metal [kg/(mm·m <sup>2</sup> )] × nominal thickness (mm)	Rounded off to 4 significant figures.
Unit mass after coating kg/m <sup>2</sup>		Unit mass of base metal (kg/m <sup>2</sup> ) + coating mass constant (kg/m <sup>2</sup> ) <sup>c)</sup>	Rounded off to 4 significant figures.
Sheet and corrugated sheet	Area of sheet and corrugated sheet <sup>d)</sup> m <sup>2</sup>	Width (mm) × length (mm) × 10 <sup>-6</sup>	Rounded off to 4 significant figures.
	Mass of a single sheet kg	Unit mass after coating (kg/m <sup>2</sup> ) × area (m <sup>2</sup> )	Rounded off to 3 significant figures.
	Mass of a single bundle <sup>e)</sup> kg	Mass of single sheet (kg) × number of sheets in a single bundle of the same dimensions	Rounded off to integral number of kg.
	Total mass kg	Total mass of each bundle (kg)	Integral number of kg.
Coil	Unit mass of coil kg/m	Unit mass after coating (kg/m <sup>2</sup> ) × width (mm) × 10 <sup>-3</sup>	Rounded off to 3 significant figures.
	Mass of a single coil kg	Unit mass of coil (kg/m) × length (m)	Rounded off to integral number of kg.
	Total mass kg	Total mass of each coil (kg)	Integral number of kg.
Notes <sup>a)</sup> Rounding off of the numerical values shall be in accordance with rule A of <b>JIS Z 8401</b> .			
<sup>b)</sup> Basic mass of base metal per thickness of 1 mm × area of 1 m <sup>2</sup>			
<sup>c)</sup> The coating mass constants shall be as given in table 28.			
<sup>d)</sup> The width dimensions to be used for the calculation of the area of the corrugated sheet shall be those before corrugation.			
<sup>e)</sup> The number of sheets, when the bundle mass is specified, shall be obtained by dividing the specified mass by the mass of a single sheet of the same shape, dimensions and coating mass, to be rounded off to an integral number.			

**Table 28 Coating mass constants for mass calculation**

Non-alloyed coating

Unit : kg/m<sup>2</sup>

Coating mass symbol	Z06	Z08	Z10	Z12	Z14	Z18	Z20	Z22	Z25	Z27	Z35	Z37	Z45	Z60
Coating mass constant	0.090	0.120	0.150	0.183	0.203	0.244	0.285	0.305	0.350	0.381	0.458	0.481	0.565	0.722

Alloyed coating

Unit : kg/m<sup>2</sup>

Coating mass symbol	F04	F06	F08	F10	F12	F18
Coating mass constant	0.060	0.090	0.120	0.150	0.183	0.244

#### 11.4 Tolerances on theoretical mass of sheet and corrugated sheet

Tolerances on the theoretical mass of sheets and corrugated sheets, which are expressed as the percentage obtained by dividing the difference between the theoretical mass obtained in accordance with 11.3 and the actual mass by the theoretical mass, shall be as given in table 29.

**Table 29 Tolerances on mass**

Theoretical mass of a single lot <sup>a)</sup> kg	Tolerance %
Under 600	± 10
600 or over to and excl. 2 000	± 7.5
2 000 or over	± 5
Note <sup>a)</sup> Calculation shall be made regarding one lot of sheets of the same quality, shape, dimensions and coating mass.	

## 12 Appearance

The sheets, corrugated sheets and coils shall be free from defects detrimental to use. However, since it is difficult to detect defects extend the entire length of coils in general, and it has no opportunity to remove defects, the coil may contain some irregular portions or such weld. When the treatment for irregular portion is needed, the method may be in accordance with the agreement between the purchaser and the supplier.

In addition, unless otherwise specified, defects on the surface shall be applied to the one-sided surface <sup>6)</sup> of sheets, corrugated sheets and coils.

NOTE: Defects include hole, lamination, surface flaw, etc.

Note <sup>6)</sup> The one-sided surface, usually, refers to a surface of the upper side in packaging for the sheets and corrugated sheets and the outside surface of coils for the coils.

## 13 Tests

### 13.1 Analysis test

#### 13.1.1 General matter of analysis test and sampling method of specimen

The chemical composition of the sheets, corrugated sheets and coils shall be obtained by the heat analysis, and the general matters of analysis test and the sampling method of specimens shall be in accordance with clause 8 of JIS G 0404.

#### 13.1.2 Analytical method

The analytical method shall be in accordance with JIS G 0320.

### 13.2 Coating test

#### 13.2.1 Sampling method

The sampling method for each product of same dimensions and coating mass shall be as follows.

For the corrugated sheet, the sample shall be taken from the sheet before corrugation.

- a) For the continuously coated coil or the cut length thereof, one sample shall be taken from every 50 t or fraction thereof.
- b) For the sheet of which coating is applied to the base metal after cut to specified lengths, one sample shall be taken from every 3 000 sheets or fraction thereof.

#### 13.2.2 Coating mass test

The coating mass test shall be as follows.

- a) **Test method** The coating mass shall be measured on both surfaces and the test method shall be in accordance with any one of 5.2 of JIS H 0401, Annex JC or Annex JD. However, when any doubt arises, it shall be in accordance with 5.2 of JIS H 0401.

In the case of the method of Annex JD, measure each 50 t of the same dimension, same coating mass and fraction thereof.

- b) **Sampling position and size and number of test pieces** The sampling position and size and number of test pieces shall be as follows;
  - 1) The sampling position and number of test pieces in the case of the method in 5.2 of JIS H 0401 shall be in accordance with JC.5.2. The size of the test piece shall be 1 200 mm<sup>2</sup> or over.
  - 2) The sampling position and size and number of test pieces in the case of the method in Annex JC shall be in accordance with JC.5.
  - 3) In the case of the method in Annex JD, the test piece shall not be sampled and measure the coil directly.

#### 13.2.3 Adhesiveness test of the coating

The adhesiveness test of the coating by the bend test shall be as follows;

- a) **Sampling position and size of test piece** The sampling position of test pieces shall be arbitrary in the sample. The test piece shall have a width of 75 mm to 125 mm and a suitable length of about twice the width. Unless otherwise specified, one test piece shall be taken from the sample parallel to the rolling direction of the base metal.



- b) **Bending of test piece** The test piece shall be bent manually with a vise at 180° in the longitudinal direction of the test piece as shown in figure 4 with sandwiching the number of sheets specified in tables 6 or 7 as internal spacing. When a hand vise is not available, other suitable means of testing may be adopted.

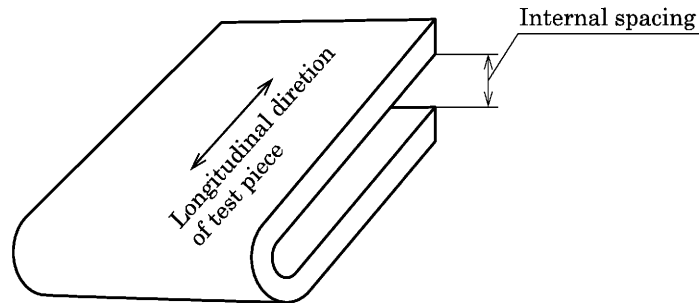

**Figure 4 Bending direction**

#### **13.2.4 Corrosion resistance test of coating**

The corrosion resistance test of coating shall be performed by any one of the methods clause 8 of JIS H 8502, Annex 1 of JIS K 5600-7-9 or JIS G 0594.

This test shall be performed in accordance with the agreement between the purchaser and the supplier, and the evaluation criteria (setting of reference value and characteristics value) may be agreed between the purchaser and the supplier.

NOTE : In the corrosion resistance test of coating, in general, the test result is often reported without specifying evaluation criteria.

### **13.3 Mechanical test**

#### **13.3.1 General matter**

The general matters of the mechanical test shall be in accordance with clause 7 and clause 9 of JIS G 0404. In this case, the sampling method shall be Class A of 7.6 of JIS G 0404, and for corrugated sheets the sample shall be taken from the sheet before corrugation. The number and the sampling position of the test pieces shall be as follows.

- a) **Number of test pieces** One bend test piece and one tensile test piece shall be taken from every 50 t or fraction thereof of the products of the same grade, thickness and coating mass, respectively.
- b) **Sampling position of test piece** The centre of the test piece shall be located at a position of 1/4 width or near the position.

#### **13.3.2 Bend test**

The bend test shall be in accordance with 13.2.3.

The bend test may be omitted <sup>7)</sup>, however when particularly designated by the purchaser, the test shall be performed.

Note <sup>7)</sup> The test may be omitted by the judgement of the manufacturer on the precondition that bendability shall satisfy the specified value.

### 13.3.3 Tensile test

The tensile test shall be as follows.

- a) **Test piece** The test piece shall be No. 5 test piece of JIS Z 2201, and one shall be taken from the sample in the direction as given in table 11 and table 12.
- b) **Test method** The test method shall be in accordance with **JIS Z 2241**.
- c) **Thickness used for calculation of yield point or proof stress, and tensile strength** The thickness used for calculation of yield point or proof stress, and tensile strength shall be in accordance with any of the following.
  - actual measured thickness after removing the coating layer
  - thickness obtained by subtracting the equivalent coating thickness from the actual measured thickness including the coating layer
  - thickness obtained by subtracting the coating thickness <sup>8)</sup> converted by the actual measured coating mass from the actual measured thickness including the coating layer

Note <sup>8)</sup> The converted coating thickness is obtained by dividing the measured coating mass by the coating density (7.14 g/cm<sup>3</sup> for non-alloyed coating and 7.21 g/cm<sup>3</sup> for alloyed coating) and by rounding off to three decimal places expressing in mm.

## 14 Inspection and re-inspection

### 14.1 Inspection

The inspection shall be as follows.

- a) Chemical composition shall comply with clause 4.
- b) Coating mass shall comply with 5.2.
- c) Coating adherence shall comply with 5.4.
- d) Mechanical properties shall comply with clause 8.
- e) Dimensions shall comply with clause 9.
- f) Shapes shall comply with clause 10.
- g) Mass shall comply with clause 11.
- h) Appearance shall comply with clause 12.

### 14.2 Re-inspection

For the sheets, corrugated sheets and coils having failed to meet the requirements of the coating mass test, the coating adherence test, the bend test or the tension test, retests may be performed for acceptance in accordance with 9.8 of JIS G 0404.

## 15 Marking

For each package or bundle of the sheets, corrugated sheets and coils that have passed the inspection, the following items shall be legibly marked by a suitable means. When agreed between the purchaser and the supplier, the following items may be marked on individual sheet and corrugated sheet by a suitable means.

- a) Grade symbol
- b) Symbol for roofing, symbol for architectural siding, and/or symbol for the corrugated sheet (including the shape symbol for the corrugated sheet). These symbols shall be marked after the grade symbol.
- c) Symbol for surface finish, symbol for skin-pass treatment and/or symbol for chemical treatment, symbol for oiling. These symbols shall be marked when designated by the purchaser.
- d) Coating mass symbol
- e) Dimensions (See 9.1. Only the nominal thickness for one sheet.)
- f) Identification number of product
- g) Number of sheets or mass (May be omitted for one sheet.)
- h) Manufacturer's name or its identifying brand

Marking shall be as shown in the following examples.

**Example 1 Sheet**

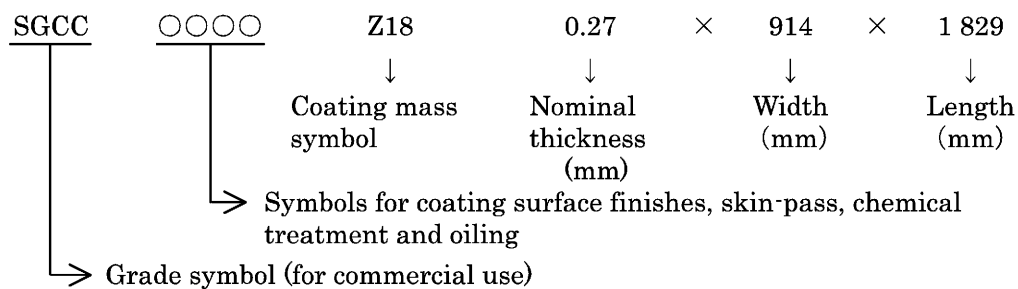

**Example 2 Coil**

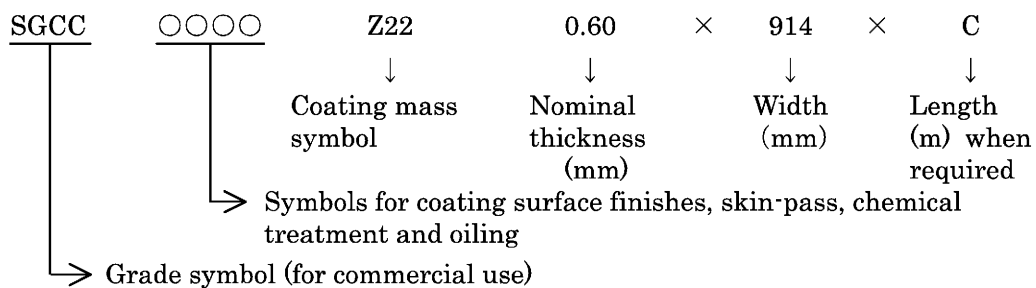

**Example 3 Coil for roofing**

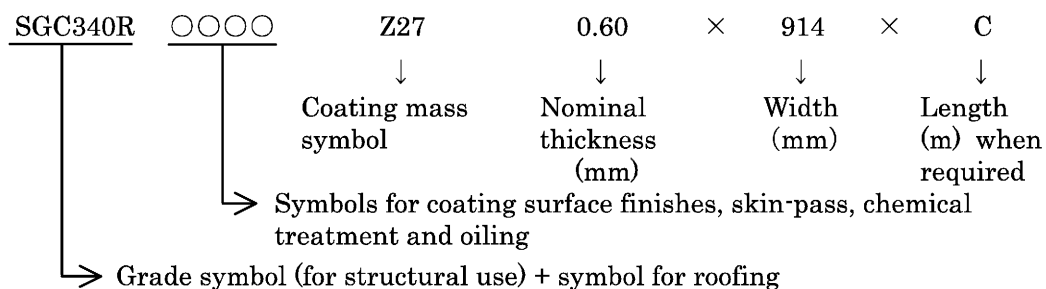

**Example 4** Corrugated sheet for architectural siding using sheet of commercial use of hard class

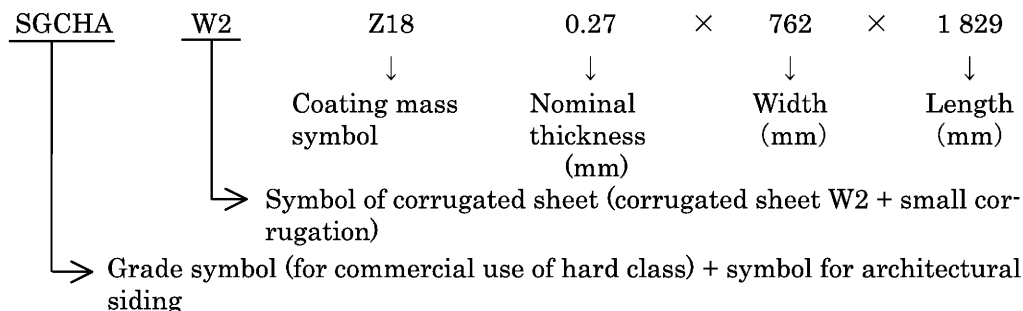

**16 Items to be confirmed at the time of order**

The purchaser and the supplier should include the following information in an inquiry sheet and an order sheet in order to designate the requirements according to this Standard properly.

- a) Grade symbol (table 1 and table 2)
- b) Dimensions (For standard nominal thickness, standard width and standard length, table 13 and table 14. For corrugated sheets, table JB.2 and JB.3 and JIS G 3316)
- c) Symbol for coating surface finish (table 5)
- d) Skin-pass treatment
- e) Coating mass symbol (table 4)
- f) Symbol for chemical treatment (table 8)
- g) Symbol for oiling (table 9)
- h) Maximum mass and minimum mass of one bundle or one coil of product
- i) Total mass ordered
- j) Tolerance on width (table 19 and table 20 or table 21)
- k) Internal diameter and external diameter for coil
- l) Application, processing method, etc. when possible

**17 Report**

When there is a request from the purchaser beforehand, the manufacturer shall submit the inspection document to the purchaser. In this case, the report shall conform to clause 13 in JIS G 0404. In the case where there is no special designation at the time of order, the type of inspection document shall be in accordance with 2.3 or 3.1.B of table 1 in JIS G 0415.

## **Annex JA (normative)**

### **Nominal thickness and coating mass symbol of sheet and coil for roofing and architectural siding**

#### **JA.1 Scope**

This Annex specifies the nominal thickness and the coating mass symbol applicable to sheets and coils (using cold-reduced base metal) for roofing and architectural siding.

#### **JA.2 Applicable nominal thickness and coating mass symbol**

The nominal thickness and the coating mass symbol applicable to the sheet and coil for roofing and architectural siding shall be as given in table JA.1.

**Table JA.1 Applicable nominal thickness and coating mass  
symbol (cold-reduced base metal is used)**

Application	Applicable nominal thickness mm	Coating mass symbol <sup>a)</sup>
For roofing	0.35 or over up to and incl. 1.0	Z25, Z27
	Over 1.0	Z27
For architectural siding	0.27 or over up to and incl. 0.50	Z18, Z22, Z25, Z27
	Over 0.50 up to and incl. 1.0	Z22, Z25, Z27
	Over 1.0	Z27
Note <sup>a)</sup> Application of Z35, Z37, Z45 and Z60 may be agreed between the purchaser and the supplier.		

## Annex JB (normative)

### Nominal thickness, coating mass symbol and standard dimension for corrugated sheet

#### JB.1 Scope

This Annex specifies the nominal thickness, the coating mass symbol and the standard dimensions applicable to the corrugated sheet.

#### JB.2 Applicable nominal thickness and coating mass symbol

The nominal thickness and coating mass symbol applicable to corrugated sheets shall be as given in table JB.1.

**Table JB.1 Applicable nominal thickness and coating mass symbol (cold-reduced base metal is used)**

Applicable nominal thickness mm	Coating mass symbol <sup>a)</sup>	Application (informative)
0.11 or over to and excl. 0.16	Z12	Specific field of application
0.16 or over to and excl. 0.27		—
0.27 or over up to and incl. 0.30		Specific field of application
Over 0.30 up to and incl. 0.50	Z18, Z22, Z25, Z27	—
Over 0.50 up to and incl. 1.0	Z22, Z25, Z27	
Note <sup>a)</sup> Application of Z35, Z37, Z45 and Z60 may be agreed between the purchaser and the supplier.		

#### JB.3 Standard dimensions

##### JB.3.1 Standard nominal thickness

The standard nominal thickness of the corrugated sheet shall be as given in table JB.2. Values in parentheses shall be applied to the specific field of application for Z12.

**Table JB.2 Standard nominal thickness**

Unit : mm

Standard nominal thickness								
(0.11)	(0.12)	(0.13)	(0.14)	(0.15)	0.16	0.17	0.19	0.20
0.25	0.27	0.30	0.35	0.40	0.50	0.60	0.80	1.0

##### JB.3.2 Standard width and length of corrugated sheet before corrugation

The standard width and length of corrugated sheet before corrugation shall be as given in table JB.3.

**Table JB.3 Standard width and standard length**

Unit : mm

Standard width before corrugation	Standard length						
762	1 829	2 134	2 438	2 743	3 048	3 353	3 658
914	1 829	2 134	2 438	2 743	3 048	3 353	3 658
1 000	2 000						

## **Annex JC (normative)**

# **Off-line test method for coating mass of hot-dipped zinc-coated steel sheet and strip using fluorescent X-ray method**

### **JC.1 Scope**

This Annex specifies the test method for measuring the coating mass of the test piece taken from the hot-dipped zinc-coated steel sheets and strips, sheets before corrugation using fluorescent X-ray apparatus.

### **JC.2 Measurement principle**

The coating mass is obtained by measuring the fluorescent X-ray strength from the coating emitted when the excited X-ray is irradiated to the specimen and comparing it to that from the specimen of known coating mass.

### **JC.3 Apparatus**

The apparatus shall be as given in clause 5 of **JIS K 0119**.

### **JC.4 Fluorescent X-rays to be measured**

The fluorescent X-ray to be measured shall be the primary ray of  $ZnK\alpha$  (wave length 14.35 nm).

### **JC.5 Test piece**

#### **JC.5.1 Size of test piece**

The test piece shall have such a size capable of being placed in a sample chamber of the fluorescent X-ray analyzer with the area of the primary X-ray irradiation to the test piece adjusted so as to be 314 mm<sup>2</sup> or more.

#### **JC.5.2 Sampling position and number of test pieces**

The test pieces shall be taken from the sample taken in accordance with **13.2.1**. Each one shall be taken from three positions as shown in figure JC.1 or the position adjacent thereto in the case of a continuous zinc-coating method and each one shall be taken from three positions as shown in figure JC.2 or the position adjacent thereto in the case of a sheet-by-sheet zinc-coating method.



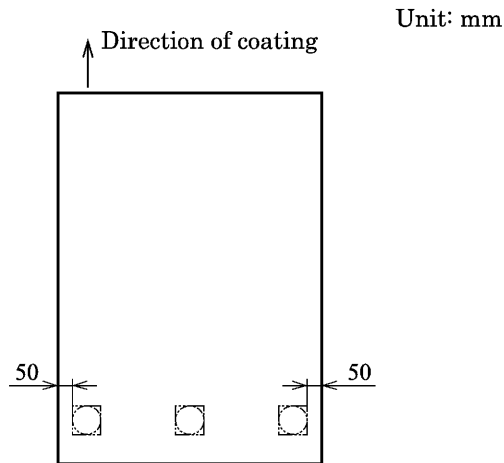

**Figure JC.1 Test piece sampling position (for continuous zinc-coating method)**

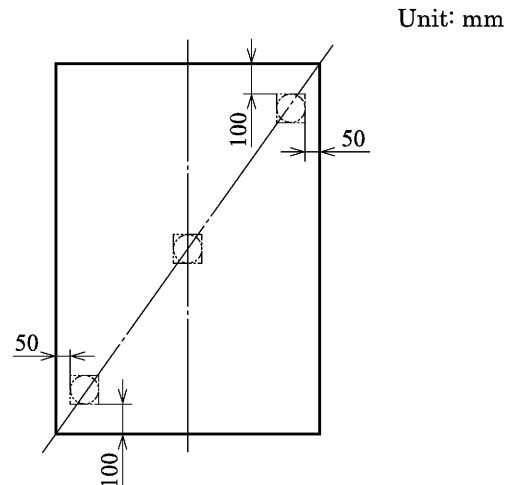

**Figure JC.2 Test piece sampling position (for sheet-by-sheet zinc-coating method)**

## JC.6 Preparation of working curve and calibration

### JC.6.1 Preparation of working curve

A working curve shall be prepared as follows. As an alternative method, however, the working curve may be prepared by obtaining the coating mass of the test piece for X-ray measurement used in **c)** in accordance with **5.2** of **JIS H 0401** without purposely cutting out another test piece for X-ray measurement. In this case, cut out the test piece for X-ray measurement so that the area is 1 200 mm<sup>2</sup> or more.

- a) Cut out test pieces for X-ray measurement to prepare a working curve and those to determine the coating mass. Take each test piece from the steel sheets or strips of the same coating type as that of the measuring object. The size of test pieces for X-ray measurement shall be such as to fit in the sample chamber, and the number of the test pieces cut out shall be one or two adjacent to each other. Cut out two test pieces for X-ray measurement to determine the coating mass so as to have an area of 1 200 mm<sup>2</sup> or more from the both sides of the test piece for X-ray measurement.
- b) Decide which surface of the test piece for X-ray measurement to irradiate excited X-rays, and measure the coating mass of that surface of the test piece for X-ray measurement to determine the coating mass in accordance with **5.2** of **JIS H 0401**. In this case, in order to prevent the coating layer from elution, use measures such as applying lacquer to the opposite side of the measurement surface and drying, or mounting a broad tape. Obtain the coating mass of the surface of the test piece for X-ray measurement irradiated with excited X-rays by averaging the coating masses of two test pieces.
- c) Place the test piece for X-ray measurement in the apparatus and measure the strength of fluorescent X-rays emitted by irradiating excited X-rays under the condition set in **JC.7 a)**.

- d) Using three or more test pieces for X-ray measurement various in coating mass, prepare the working curve based on the relationship between their strengths of fluorescent X-rays and coating masses.

### JC.6.2 Calibration of working curve

Calibrate the working curve by placing test pieces for calibration various in coating mass in the apparatus and periodically <sup>1)</sup> measuring their strengths of fluorescent X-rays or converted values of coating mass.

Note <sup>1)</sup> Measurement every 8 h, or every day is preferable.

### JC.7 Procedure

The procedure shall be as follows.

- a) Place the test piece of the minimum coating mass symbol among those to be measured in the apparatus, adjust the condition so that the relative standard deviation <sup>2)</sup> when measured consecutively ten times becomes 1 % or less and capable of reading the coating mass to the nearest 0.1 g/m<sup>2</sup>. When the X-ray strength is measured by count and the count number is 10 000 or over, however, duplicate measurements shall not be required.

Note <sup>2)</sup> The quotient obtained by dividing the standard deviation of measured values by the mean value (see **JIS K 0211**).

In the case of measuring a coating mass less than that of coating mass symbol used when the condition has been adjusted, confirm the above condition is satisfied using the test piece of relevant coating mass symbol. If the above condition is not fulfilled, readjust the condition.

- b) Mount the test piece in the sample chamber correctly.
- c) Irradiate the test piece with X-rays under the adjusted condition, and measure the fluorescent X-ray strength.
- d) Convert the fluorescent X-ray strength to the coating mass per 1 m<sup>2</sup> (one side, g/m<sup>2</sup>) using the working curve.
- e) Repeat procedures **b)** to **d)** also on the back surface of the test piece to obtain the coating mass, take the total of the coating masses of front surface and back surface as the coating mass of the test piece (both sides, g/m<sup>2</sup>).

### JC.8 Check of apparatus

Check the apparatus properly. Checking items shall be in accordance with clause 15 of **JIS K 0119** and further check whether or not the measurement result by the apparatus is normal by comparing the coating mass measurement result with the measured value obtained in accordance with 5.2 of **JIS H 0401**.

## **Annex JD (normative)**

### **Online test method for coating mass of hot-dipped zinc-coated steel strip using fluorescent X-ray method**

#### **JD.1 Scope**

This Annex specifies the test method for measuring coating mass of hot-dipped zinc-coated steel strip using the fluorescent X-ray apparatus installed in a manufacturing line.

**Warning:** When measurement and maintenance of an apparatus are carried out based on this Annex, appropriate safety measures shall be taken. Especially, to avoid exposure to radioactive ray, strict controls shall be placed on safety.

**NOTE:** The law and regulation concerning installation and handling of the apparatus used in this Annex include Industrial Safety and Health Act, Ordinance on Prevention of Ionizing Radiation Hazards, etc.

#### **JD.2 Measurement principle**

The coating mass is obtained by measuring the fluorescent X-ray strength from the coating emitted when the excited X-ray (including  $\gamma$  ray) is irradiated to the coil and comparing it to that from the specimen of known coating mass.

#### **JD.3 Apparatus**

The apparatus consists of X-ray generation part, spectroscopy-detection-counting part and system controlling-data processing part as follows. Install the apparatus in the place free from temperature and humidity changes which could significantly affect measurement results.

##### **JD.3.1 X-ray generation part**

The X-ray generation part shall be such that it is capable of irradiating the position of the coil specified in **JD.6.3** with excited X-ray (including  $\gamma$  ray) directly.

##### **JD.3.2 Spectroscopy-detection-counting part**

The spectroscopy-detection-counting part shall be such that it is capable of measuring strength of fluorescent X-ray generated at the measuring position specified in **JD.6.3**.

##### **JD.3.3 System controlling-data processing part**

The system controlling-data processing part shall be such that it is capable of controlling the X-ray generation part and spectroscopy-detection-counting part to make possible measurement of the strength of fluorescent X-ray generated by irradiation the position specified in **JD.6.3** with excited X-ray (including  $\gamma$  ray) at and capable of recording the measurement results correspond to the irradiated position.

#### **JD.4 Fluorescent X-ray to be measured**

The fluorescent X-ray to be measured shall be a primary ray of  $ZnK\alpha$  (wave length 14.35 nm). For correcting the distance between the measurement surface and the apparatus, however, X-rays of other wave length may be measured simultaneously.

#### **JD.5 Preparation of working curve and calibration**

##### **JD.5.1 Preparation of working curve**

A working curve shall be prepared as follows. As an alternative method, however, the working curve may be prepared by obtaining the coating mass of the test piece used in **c)** for X-ray measurement in accordance with **5.2** of **JIS H 0401** without purposely cutting out another test piece for X-ray measurement. In this case, the area of the test piece cut out for X-ray measurement shall be 1 200 mm<sup>2</sup> or more.

- a) Cut out test pieces for X-ray measurement to prepare a working curve and those to determine the coating mass. Take each test piece from the sheets or coils of the same coating type as that of the measuring object. The size of test pieces for X-ray measurement shall be such as to fit in the sample chamber, and the number of the test pieces cut out shall be one or two adjacent to each other. Cut out two test pieces for X-ray measurement to determine the coating mass so as to have a size of 1 200 mm<sup>2</sup> or more from the both sides of the test piece for X-ray measurement.
- b) Fix previously the surface of the test piece for excited X-ray (including  $\gamma$  ray) measurement to radiate excited X-rays, and measure the coating mass of that surface of the test piece for X-ray (including  $\gamma$  ray) measurement to determine the coating mass in accordance with **5.2** of **JIS H 0401**. In this case, in order to prevent solve out of coating layer, use measures such as to apply lacquer to the opposite side of the measurement surface and dry, or to mount a broad tape. Obtain the coating mass of the surface of the test piece for X-ray measurement irradiated with excited X-rays by averaging the coating masses of two test pieces.
- c) Place the test piece for X-ray measurement in the apparatus and measure the strength of fluorescent X-rays emitted by the irradiation of excited X-rays (including  $\gamma$  ray) under the conditions specified in **JD.6.4 a)**.
- d) Using three or more test pieces for X-ray measurement with various coating masses, prepare the working curve based on the relationship between their strengths of fluorescent X-rays and coating masses.

##### **JD.5.2 Calibration of working curve**

Calibrate the working curve in accordance with **JC.6.2**.

## **JD.6 Measurement method**

### **JD.6.1 Measurement surface**

The surface of coil of which coating mass is to be measured shall be free from adherence of stain or metal powder which could affect significantly measurement results. The distance and inclination between the measurement surface and the apparatus shall be the same as those at the time when test pieces for X-ray measurement is measured. If any deviation of the distance and inclination between the measurement surface and the apparatus which can affect significantly measurement results occurs, correct the effect.

### **JD.6.2 Measuring mode**

The mode of measuring a coating mass shall be either one of the following.

One method is that for measuring by fixing the apparatus at the specified position of coil in width direction (hereafter referred to as “fixed point mode”) during irradiating X-ray to measure the coating mass of coil.

Another method is that for measuring by moving the apparatus at constant speed in the width direction of coil (hereafter referred to as “scan mode”). Which method to choose is decided by the manufacturer.

### **JD.6.3 Measuring position of coating mass**

The measuring position of coil in the width direction shall be as shown in figure JD.1 a) in the case of fixed point mode and as shown in figure JD.1 b) in the case of scan mode. In the case of the fixed point mode, measure the coating mass at each of three positions where the distance from both side edges (ends of the width direction) of the coil to the outside edge of X-ray beam becomes  $50_{+30}$  mm and the centre of the X-ray beam coincide with the centre of board width within  $\pm 15$  mm. In the case of the scan mode, move the apparatus at a constant speed in the direction of coil width, and measure the coating mass at each of three positions within the measuring ranges (A) shown in figure JD.1 b). In this case, the measuring ranges on the edge sides show the positions of the outside edge of X-ray beam and the centre of the board width shows the centre of the X-ray beam.

Measure the coating mass on both sides of a coil. The measuring position in the width direction of the front surface of a coil shall be the same as that of the back surface and the measuring position in the length direction of front surface shall be as near as possible to that of back surface.

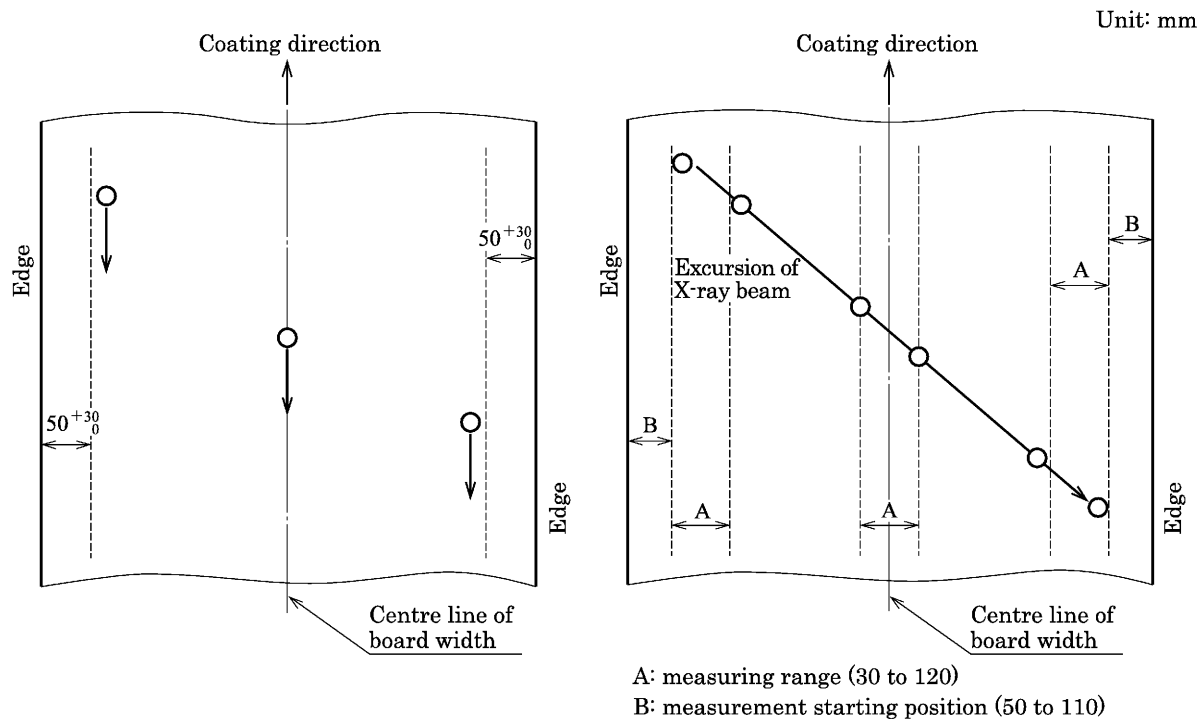

a) In the case of fixed point mode

b) In the case of scan mode

**Figure JD.1 Measuring position of coating mass**

#### JD.6.4 Measurement

The measurement shall be as follows;

- a) The measuring time of the one part shall be under four seconds. Place the test piece of the minimum coating mass symbol among those to be measured in the apparatus, adjust the condition so that the relative standard deviation <sup>1)</sup> when measured consecutively ten times on the product line setting the apparatus becomes 1 % or less and capable of reading the coating mass to the nearest 0.1 g/m<sup>2</sup>. When the X-ray strength is measured by count and the count number is 10 000 or over, however, duplicate measurements shall not be required.

Note <sup>1)</sup> The quotient obtained by dividing the standard deviation of measured values by the mean value (see **JIS K 0211**).

In the case of measuring a coating mass less than that of coating mass symbol used when the condition has been adjusted, confirm the above condition is satisfied using the test piece of relevant coating mass symbol. If the above condition is not fulfilled, readjust the condition.

- b) Irradiate the test piece with X-rays under the adjusted condition, and measure the fluorescent X-ray strength.
- c) Convert the fluorescent X-ray strength to the coating mass per 1 m<sup>2</sup> (one side, g/m<sup>2</sup>) using the working curve.

In addition, when the area of the coil is changed for skin-pass after coating mass measurement, it shall be corrected using change ratio of the area.

- d) Take the total of the coating masses of front surface and back surface as the coating mass of the one part of the test piece (both sides, g/m<sup>2</sup>).

#### **JD.6.5 Measured value of coating mass**

Obtain the average coating mass and the minimum coating mass using coating mass values at three positions in arbitrary one path <sup>2)</sup>. The path number, however, may be plural and the average coating mass and the minimum coating mass in the case of using plural paths are the average of all measured values and the minimum coating mass among all measured values, respectively.

Note <sup>2)</sup> One path means the measurement while moving the X-ray generation part from the coil edge at the arbitrary position in the coil to opposite side edge in one direction.

#### **JD.7 Check of apparatus**

Check the apparatus properly. Items to be checked shall be in accordance with clause **15** of **JIS K 0119** with the following.

- a) The temperature and humidity of the place where the apparatus is installed do not affect significantly measurement.
- b) The distance and inclination between the coil and the apparatus shall be constant at the time of measurement.
- c) The distance and inclination between the test piece and the apparatus at the time of calibration shall be the same as those at the time of measurement of the coil.
- d) The apparatus moves at constant speed in the case of scan mode.
- e) The apparatus measures the coating mass under the specified condition.
- f) The stain of the apparatus does not affect the measurement.
- g) The measurement results of coating mass with the apparatus according to this method are normal by comparing to results according to other measurement method [Annex JC or **5.2** of **JIS H 0401**].

---

#### **Bibliography**

JIS K 0211 *Technical terms for analytical chemistry (General part)*

**Annex JE (informative)**

**Comparison table between JIS and corresponding International Standards**

JIS G 3302 : 2010 <i>Hot-dip zinc-coated steel sheet and strip</i>		ISO 3575 : 2005 <i>Continuous hot-dip zinc-coated carbon steel sheet of commercial and drawing qualities</i>		ISO 4998 : 2005 <i>Continuous hot-dip zinc-coated carbon steel sheet of structural quality</i>			
(I) Requirements in JIS		(II) International Standard number	(III) Requirements in International Standard		(IV) Classification and details of technical deviation between JIS and International Standard by clause		(V) Justification for the technical deviation and future measures
No. and title of clause	Content		Clause	Content	Classification by clause	Details of technical deviation	
1 Scope	The hot-dip zinc-coated steel sheet and strip are specified.	ISO 3575	1.1	The hot-dip zinc-coated steel sheet of commercial and drawing qualities, and steel coil are specified.	Addition	In JIS, scope covers the contents of two ISO Standards. And corrugated sheets are added.	The standard structure differs between JIS and ISO Standard.
		ISO 4998	1	The hot-dip zinc-coated steel sheet and coil of structural quality are specified.			
2 Normative references							
3 Grade, symbol and applicable nominal thickness	Grade symbols and nominal thickness of 3 grades for commercial use, 4 grades for drawing use, those for high intensity commercial use and 10 grades for structural use are specified.	ISO 3575	1 4.2	Grade symbols and nominal thickness of 1 grade of commercial quality and 4 grades of drawing quality are specified.	Alteration	In JIS, the division of hot-rolled base metal and cold-reduced base metal are specified. In JIS, more grades than those in ISO Standards are specified, and the thickness range to be applied is wider than that in ISO Standards. In JIS, coating using steel sheets is added.	Based on the difference in market demands.
		ISO 4998	1 4.2	Grade symbols and nominal thickness of 7 grades of structural quality are specified.	Addition		



(I) Requirements in <b>JIS</b>		(II) International Standard number	(III) Requirements in International Standard		(IV) Classification and details of technical deviation between <b>JIS</b> and International Standard by clause		(V) Justification for the technical deviation and future measures
No. and title of clause	Content		Clause	Content	Classification by clause	Details of technical deviation	
4	Chemical composition	<b>ISO 3575</b> <b>ISO 4998</b>	4.1	The chemical composition (four elements) of base metal, upper limit of alloy element not specified and permissible variation in product analysis are specified.	Alteration	The chemical composition differs between <b>JIS</b> and <b>ISO</b> Standards. In <b>JIS</b> , the upper limit of alloy element not specified and permissible variation in product analysis are not specified.	Since the specified mechanical properties differ between <b>JIS</b> and <b>ISO</b> Standards, chemical composition differs. In <b>JIS</b> , product analysis is not specified because of no market demands.
5.1	Type of coating		1.6 1		Identical		
5.2	Coating mass		4.3.1 5.3		Alteration	In <b>JIS</b> , the more detailed coating mass than that in <b>ISO</b> Standards is specified.	The market demands for coating mass differs.
5.3	Coating surface finishes		7.3		Identical		
5.4	Coating adherence		4.3.2 5.4	The evaluation of coating adherence by bend test is specified.	Addition	Although the evaluation by bend test does not differ between <b>JIS</b> and <b>ISO</b> Standards, in <b>JIS</b> , other evaluation tests are added.	In <b>JIS</b> , the evaluation by the more accurate test method is approved upon the agreement between the purchaser and the supplier.
6	Chemical treatment		4.6.1 4.6.2	Two types of chemical treatment are specified.	Addition	In <b>JIS</b> , the chemical treatment capable of supporting environmentally restricted substances is added.	The proposal of addition of chemical treatment symbols to <b>ISO</b> Standards will be submitted.
7	Oiling		4.6.3		Identical		

(I) Requirements in <b>JIS</b>		(II) International Standard number	(III) Requirements in International Standard		(IV) Classification and details of technical deviation between <b>JIS</b> and International Standard by clause		(V) Justification for the technical deviation and future measures
No. and title of clause	Content		Clause	Content	Classification by clause	Details of technical deviation	
8 Mechanical properties	Bendability and tensile test characteristics (yield point or proof stress, tensile strength, and elongation) as mechanical properties are specified.	<b>ISO 3575</b> <b>ISO 4998</b>	4.2	Tensile test characteristics (yield point or proof stress, tensile strength, and elongation) are specified.	Addition	In <b>JIS</b> , bendability is added.	The bend test in <b>JIS</b> can be omitted, and the deletion of bendability will be studied in the future.
					Alteration	The tensile test characteristics differ between <b>JIS</b> and <b>ISO</b> Standards.	The tensile test characteristics are based on the difference in market demands.
9.1 Expression of dimensions			1 Annex A	For thickness, either product thickness or base metal thickness is used.	Deletion	For thickness in <b>JIS</b> , base metal thickness is used.	In <b>JIS</b> , from the viewpoint of commercial practice, base metal thickness is used. Although in <b>ISO</b> Standards only product thickness was specified, the proposal of addition of use of base metal thickness was submitted and adopted in <b>ISO</b> Standards published in 2005.
9.2 Standard dimensions	Standard dimensions are specified.		—	—	Addition	In <b>JIS</b> , standard dimensions are added.	In <b>JIS</b> , from the viewpoint of commercial practice, it is necessary to specify standard dimensions.
9.3 Dimensional tolerances	Dimensional tolerances are specified.		4.8 Annex A		Alteration	Dimensional tolerances differ between <b>JIS</b> and <b>ISO</b> Standards.	Dimensional tolerances are specified based on the tolerances on hot-rolled steel sheet and cold-reduced base metal.

(I) Requirements in <b>JIS</b>		(II) International Standard number	(III) Requirements in International Standard		(IV) Classification and details of technical deviation between <b>JIS</b> and International Standard by clause		(V) Justification for the technical deviation and future measures
No. and title of clause	Content		Clause	Content	Classification by clause	Details of technical deviation	
10 Shapes	Shapes are specified.	<b>ISO 3575</b> <b>ISO 4998</b>	4.8		Alteration	Tolerances on shapes differ between <b>JIS</b> and <b>ISO</b> Standards.	Tolerances on shapes are specified based on tolerances on hot-rolled steel sheet and cold-reduced steel sheet. The proposal of revision of tolerances on flatness in <b>ISO</b> Standards was submitted, and is under review as of 2009.
11 Mass and tolerances thereof	Mass of sheets and coils is specified.		—	—	Addition	In <b>JIS</b> , the measured mass or the calculated mass is used.	In <b>JIS</b> , from the view-point of commercial practice, it is necessary to specify mass.
12 Appearance			9		Identical		
13.1 Analysis test	Sampling method and analytical method are specified.		4.1 5.1	The concrete sampling method and analytical method are not specified. The heat analysis is performed by the manufacturer, and the product analysis is performed by the purchaser as necessary.	Addition	In <b>JIS</b> , the sampling method and analytical method are concretely specified.	Since the standard system differs between <b>JIS</b> and <b>ISO</b> Standards, it is necessary to specify concretely.
13.2 Coating test	Coating mass test, adhesion test and corrosion-resistant test are specified.		5.3 5.4 6.2.1 6.2.2	The coating mass test and coating adherence test are specified.	Addition	In <b>JIS</b> , the corrosion resistance test of coating is added.	Added in <b>JIS</b> since the data on corrosion resistance may be requested by the purchaser.

(I) Requirements in <b>JIS</b>		(II) International Standard number	(III) Requirements in International Standard		(IV) Classification and details of technical deviation between <b>JIS</b> and International Standard by clause		(V) Justification for the technical deviation and future measures
No. and title of clause	Content		Clause	Content	Classification by clause	Details of technical deviation	
13.3 Mechanical test	Test pieces and test methods in the bend test and tensile test are specified.	<b>ISO 3575</b> <b>ISO 4998</b>	4.2 5.2 6.1 6.2.2		Alteration	The shape of tensile test piece differs between <b>JIS</b> and <b>ISO</b> Standards.	In <b>JIS</b> , the original shape of tensile test piece of <b>JIS</b> is used.
14.1 Inspection	Inspection is specified.		—	—	Addition	In <b>JIS</b> , inspection is specified by arranging it into one clause, and in <b>ISO</b> Standards it is specified by using separate clauses.	The standard system differs between <b>JIS</b> and <b>ISO</b> Standards.
14.2 Re-inspection			5.5		Identical		
15 Marking	Items to be marked are specified.		7 11		Addition	In <b>JIS</b> , the markings for roofing, architectural siding and corrugated sheets are added.	In <b>JIS</b> , symbols for roofing, architectural siding and corrugated sheet are added.
16 Items to be confirmed at the time of order			12		Addition	In <b>JIS</b> , dimensions of corrugated sheets are added.	
17 Report	Report is specified.		—	—	Addition	In <b>JIS</b> , report is added.	In <b>JIS</b> , since from the viewpoint of commercial practice report may be required, it is necessary to specify.
Annex JA (normative)	Nominal thickness and coating mass symbol for sheet and coil for roofing and architectural siding are specified.		—	—	Addition	In <b>JIS</b> , the specification for roofing and architectural siding is added.	It is necessary to specify for the specific application.

(I) Requirements in <b>JIS</b>		(II) Inter- national Standard number	(III) Requirements in Inter- national Standard		(IV) Classification and details of technical deviation between <b>JIS</b> and International Standard by clause		(V) Justification for the technical deviation and future measures
No. and title of clause	Content		Clause	Content	Classifica- tion by clause	Details of technical deviation	
Anne JB (normative)	Nominal thickness, coating mass symbol and standard dimen- sion for corrugated sheet are specified.	<b>ISO 3575</b> <b>ISO 4998</b>	—	—	Addition	In <b>JIS</b> , the specification of corrugated sheets is added.	The corrugated sheets are the product originally specified in <b>JIS</b> , and therefore it is necessary to specify.
Annex JC (normative)	The specification of the off-line test method for the coating mass using fluorescent X-rays is specified.		—	—	Addition	Although the test method for the coating mass is speci- fied in <b>JIS</b> , not specified in <b>ISO</b> Standards.	In <b>JIS</b> , it is necessary to specify of the coating mass test method.
Annex JD (normative)	The specification of the online test method for the coating mass using fluorescent X-rays is specified.		—	—	Addition	Although the test method for the coating mass is specified in <b>JIS</b> , not speci- fied in <b>ISO</b> Standards.	In <b>JIS</b> , it is necessary to specify of the coating mass test method.
—	—		3	Terms and definitions are specified.	Deletion	Deleted in <b>JIS</b> .	In <b>JIS G 0203</b> , terms are defined.
—	—		8	The resubmission for acceptance when the products have been rejected during earlier inspection is specified.	Deletion	Deleted in <b>JIS</b> .	Specified in the normative reference of <b>JIS G 0404</b> .
—	—		10	Attendance inspection is specified.	Deletion	Deleted in <b>JIS</b> .	Specified in the normative reference of <b>JIS G 0404</b> .

Overall degree of correspondence between **JIS** and International Standards (**ISO 3575** : 2005, **ISO 4988** : 2005) : MOD

NOTE 1 Symbols in sub-columns of classification by clause in the above table indicate as follows :

- Identical : Identical in technical contents.
- Deletion : Deletes the specification item(s) or content(s) of in International Standards.
- Addition : Adds the specification item(s) and content(s) which are not included in International Standards.
- Alteration : Alters the specification content(s) which are included in International Standards.

NOTE 2 Symbol in column of overall degree of correspondence between **JIS** and International Standards in the above table indicates as follows :

- MOD : Modifies International Standards.

Errata for JIS (English edition) are printed in *Standardization and Quality Control*, published monthly by the Japanese Standards Association, and also provided to subscribers of JIS (English edition) in *Monthly Information*.

Errata will be provided upon request, please contact:  
**Standards Publishing Department, Japanese Standards Association**  
4-1-24, Akasaka, Minato-ku, Tokyo, 107-8440 JAPAN  
TEL. 03-3583-8002 FAX. 03-3583-0462